

Inhalation

Complete Toxicology Systems



Contents

■ Modular Inhalation Systems	3
■ Head Nose Only Exposure Units	6
■ Head Snout Only Exposure Units	10
■ Whole Body Exposure Units	12
■ Environmental Sensors	15
■ Aerosol Conditioning Units	16
■ Liquid Aerosol and Vapor Generators	18
■ Aerosol Generators for Special Applications	20
■ Dust Generators	21
■ Cigarette Smoke Generators	22
■ Offline Aerosol Analysis	24
■ Real-Time Aerosol Analysis	25
■ Inhalation Software	27
■ Cell Culture Exposure System	29
■ NanoTechnology	30

Modular Inhalation Systems

Complete Solutions for Inhalation Studies



Whole Body Unit with a volume of approx. 0.95 m³



Head Nose Only Unit with 9 segments

TSE Systems develops and produces state-of-the-art exposure systems by the continual further development of the systems and their components. They are in accordance with advances in technology and developed in consultation with experts from leading research institutes and universities. TSE inhalation systems are suitable for long-term and short-term investigations in pharmacology, toxicology, environmental and occupational safety, as well as for pharmacology and toxicology.

Head Nose Only and Whole Body Exposure Systems are available in single or multi-place configuration. A wide range of different versions of exposure units are available including custom-made models. The specification of the peripheral instruments is made in accordance with the design and size of the exposure system:

- The generation of a supply air flow
- Liquid and dust aerosol generation & conditioning

- Cigarette smoke generation acc. to ISO
- Generation and conditioning of vapors (e.g. VOCs)
- Sampling and analysis equipment
- Protective units such as substance-adapted filters
- Exhaust air management

Fitting out the inhalation system takes place in consultation with the user taking the project target into consideration, so customers receive entirely customized systems. Standardized components are used which can be assembled modularly to provide an efficient tool for scientific research – special system adaptations according to particular requirements are possible.

As after-sales service, TSE Systems offers individual training for technical and scientific staff, (on request in your own laboratory), as well as providing support during the familiarization period with the new system.

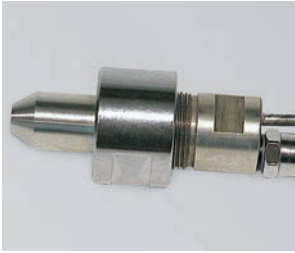

Aerosol nozzle



Aerosol conditioning unit



Temperature & humidity sensor



Pressure sensor

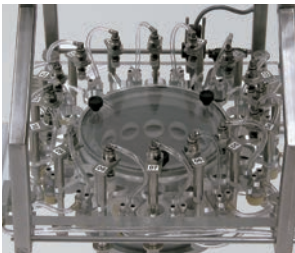

MDI Activator mixing unit



Dust generator

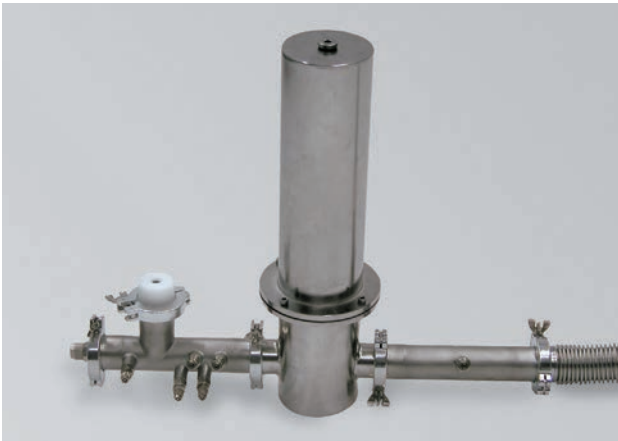

Exhaust filter with adaptor for sensor unit



Cascade impactor



Sample filter unit

Modular Exposure Systems

According to the system requirements, the modular design permits working with liquid and dust aerosols, vapors and special applications such as metered dosed inhalers. Special exposure systems for administering cigarette smoke are available.

The exposure units are available for animals from mouse to dog sizes as standard versions; for larger animals according to the user's specifications. Small or larger numbers of animals can be used; this depends on the system design and size.

Tests can be carried out with a slight vacuum or slight over-pressure in the inhalation system. For real-time and offline analysis of the test atmosphere numerous different sampling instruments are available.

Exhaust air filtering and cleaning is adapted to the type of test substance and includes special fume hood systems.

Experimental design

In the initial stages during the presales phase TSE Systems provides expert consultation for optimal system installation in the laboratory. Aerosol and vapor generation is adapted to the physical-chemical properties of the test substance – solutions even for substances that are difficult to evaporate.

Regulations and control devices as well as data recording are designed according to the experimental conditions – automatic control of flow, pressure, test parameters and the data acquisition.

A homogeneous concentration profile results from the uniform aerosol distribution and good aerodynamic performance in the exposure unit.

Additionally, TSE Systems provides support and advice for validating systems to OECD and EPA guidelines and GLP requirements. Optional components can be added at a later date or taken into account during the planning phase.

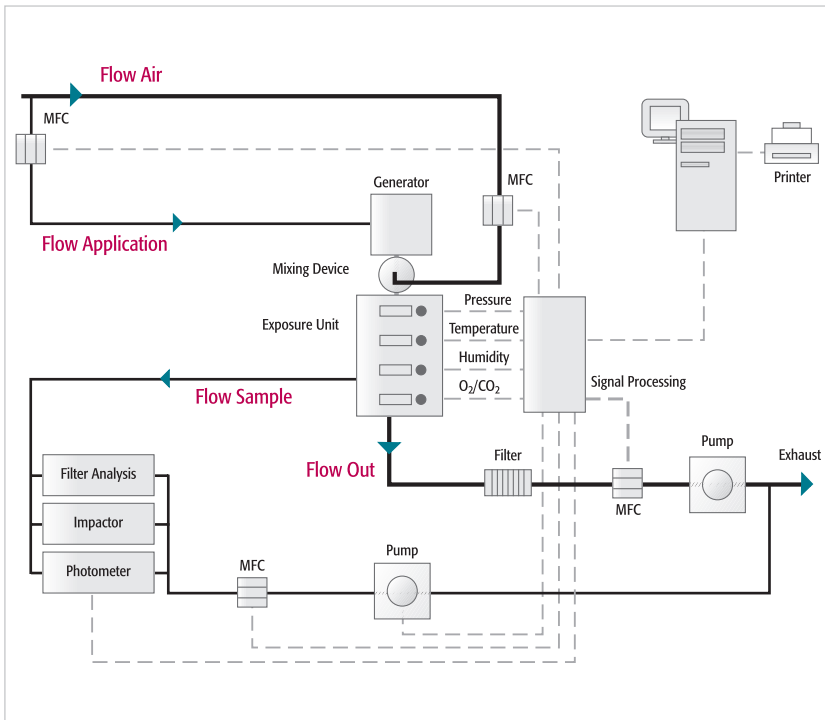

System overview – principal components and functional sections



Mounting wall with system components

Technical realization

Standardized individual components allow the exposure system to be adapted to meet the project target according to the particular test substance, test conditions and size of the exposure unit.

- Flow regulation via electronically controlled mass flow controllers (MFCs), pumps and air pressure generators
- Extension by mechanical flow meters for manual flow checks
- Pressure regulation in the exposure system by electronically measuring pressure values using an appropriate sensor
- Generation of liquid and dust aerosols via various aerosol generating units, e.g. two-stream nozzle, Dust Generator acc. to Wright, etc.
- Vapor generation in accordance with the required test atmosphere and test substance used

Inhalation studies can be performed via Head Nose Only or Whole Body Exposure Units or special inhalation units manufactured according to the customer's needs. Mounting plates and cabinets for secure and space-saving installation of equipment are designed according to the specific requirements.

Both complete systems and individual functional sections are equipped with the necessary components, e.g.:

- Sensors for recording test parameters such as O₂ and CO₂ concentration, pressure, humidity or temperature – special sensors available on request
- Sampling line for aerosol characterization, e. g. particle size distribution using real-time and offline analysis methods
- Filter systems matched to the particular test substance for purifying the test atmosphere and exhaust air to protect the environment, the system operators and system components
- Software-guided test setup and control as well as data monitoring and acquisition
- Fume cupboards specially designed for the particular system can be manufactured on request

Head Nose Only Exposure Units



Head Nose Only Unit with aerosol conditioning units



Head Nose Only Unit with one segment

Overview

The modular design of the Head Nose Only Units allows them to be adapted to suit the customer's requirements. The basic structure consists of single segments which can be stacked up on top of each other. The number of connections for measuring devices is also adapted to meet the requirements.

The restrainer construction is designed for simple operation, quick replacement and easy cleaning.

Head Nose Only Units are characterized by:

- Controlled administration of the test substance via the nose – in particular, reduced skin and fur contamination
- Low sample consumption – particularly advisable for highly toxic or expensive test substances or when the test substance is in short supply
- Usability for short-term exposure tests with rapid achievement of the equilibrium concentration and by rapid flooding with fresh air at the end of the exposure

Mobile versions or standing versions for use in fume cupboards are available and usable for a wide range of species – mouse up to guinea pig size is standard. Special exposure units for dog inhalation studies can also be provided.

Further component features:

- Using different preconditioning units via central aerosol administration is possible as standard
- Also suitable for the application of vapors if components are adapted – including custom-made models
- Small size exposure units completely made of stainless steel for fume hood application
- Different sizes of animal cages including animal restrainers
- Animal cages made from glass or other materials suitable for special applications

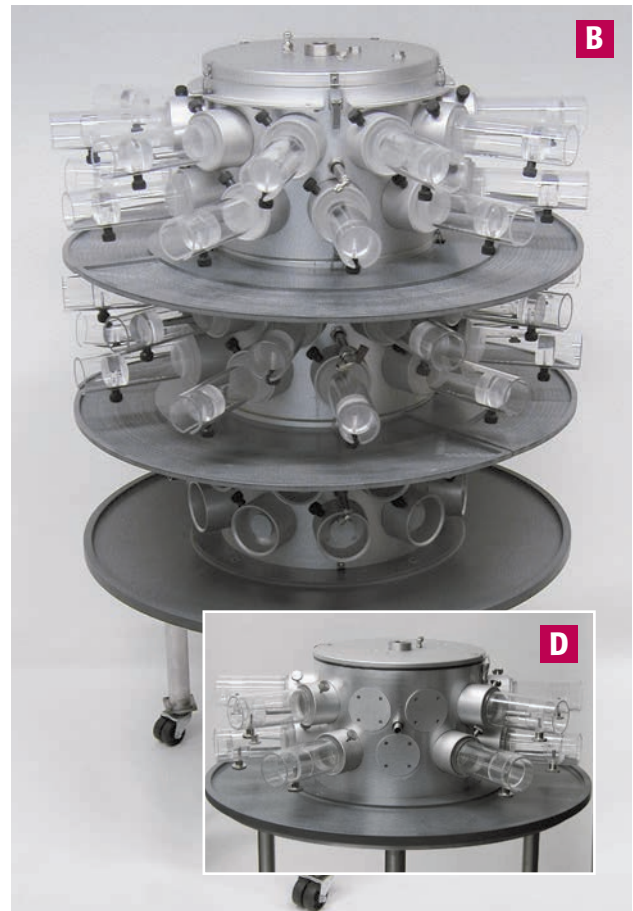
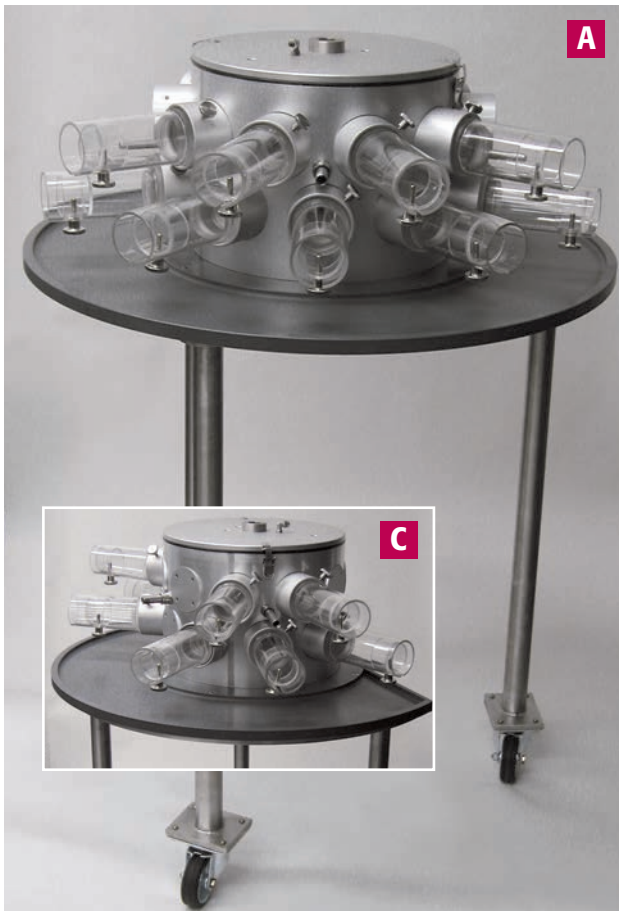

Examples of Head Nose Only Exposure Units

Head Nose Only Units with complete port numbers

A Head Nose Only Unit with 20 ports and excrement tray for animal feces – basic module, can be extended to accommodate larger numbers of animals

B Head Nose Only Unit with 60 ports and 3 sampling connections per segment; the ports can be sealed with rubber stoppers for a technical check of the system or if they are not in use

Head Nose Only Units with reduced port numbers

C Head Nose Only Unit with 10 ports and reduced excrement tray diameter for use in small rooms or for placement directly against a wall

D Head Nose Only Unit with a reduced number of ports for use with a smaller numbers of animals – can be extended as required

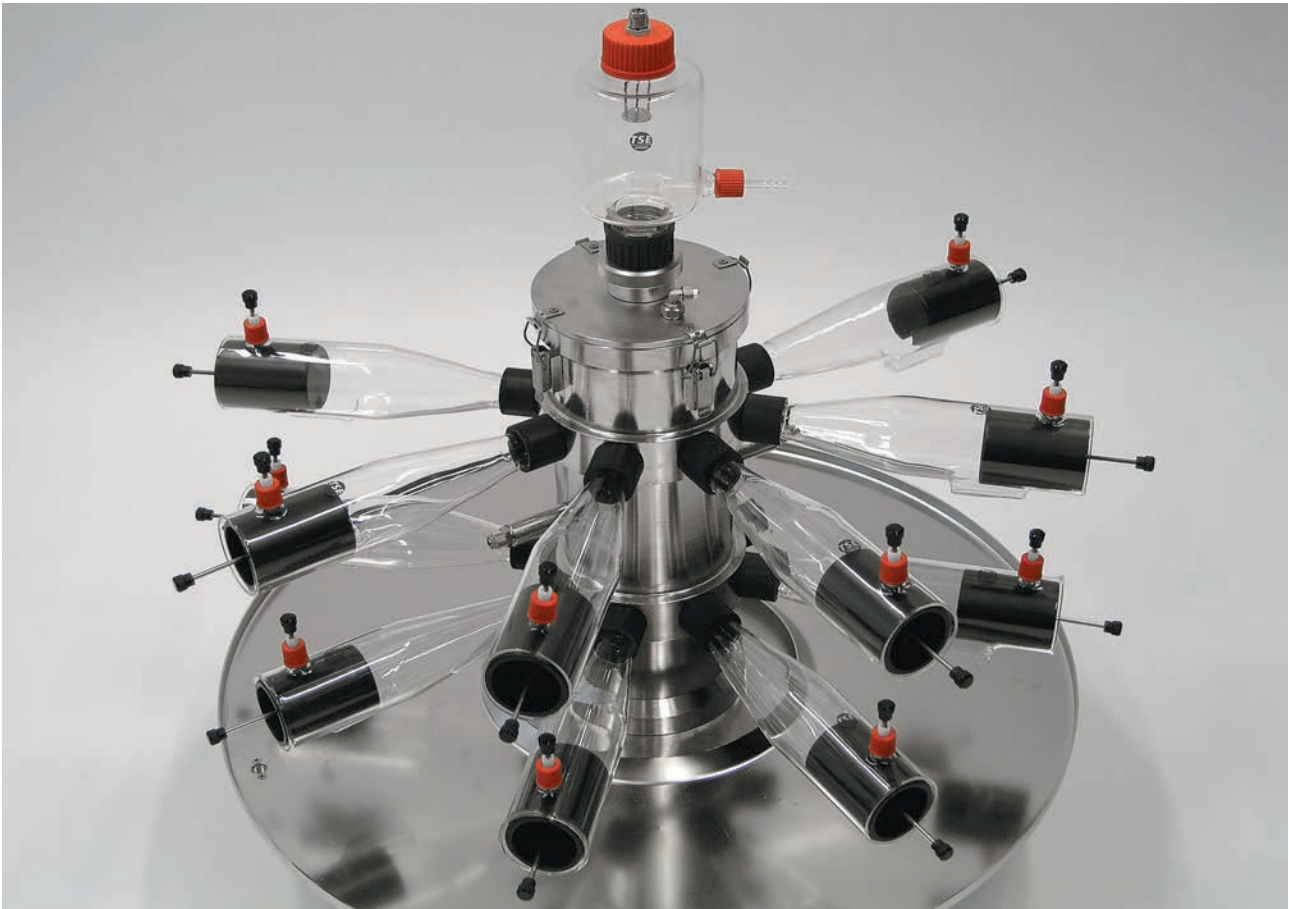

Head Nose Only Unit made of stainless steel with glass restrainers and mixing device with impactor plate for dust aerosols

Various Custom-Made Designs

TSE Systems also manufactures Head Nose Only Units according to the user's requirements; their design and configuration is developed in consultation with the customer.

For example, Head Nose Only Units are available with glass cages and special sealing material for use with aggressive chemicals or radioactive substances.

Further special versions are possible with respect to:

- Dimensions specially for use with inclined fume hoods
- Designs with extra short legs to achieve a small unit height for placing under a fume hood – also mobile exposure units on casters with brakes
- Exposure units made of other materials such as stainless steel, according to the particular application

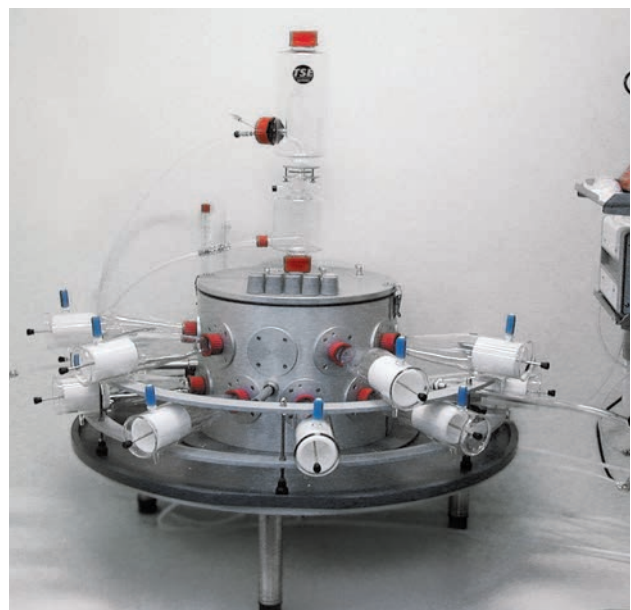

Head Nose Only Unit in fume cupboard with mounting panel

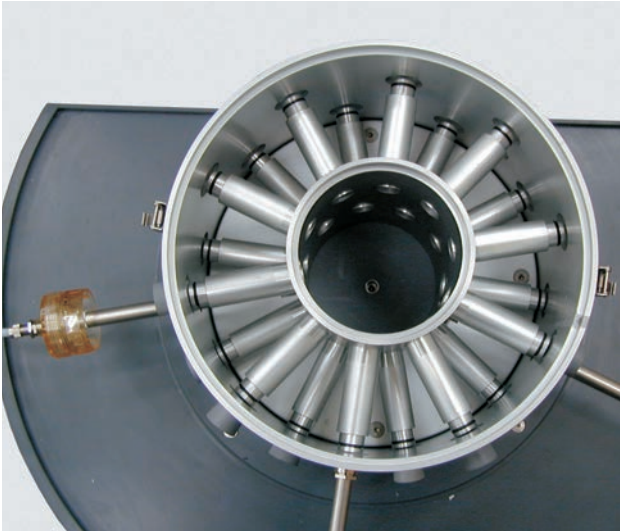

A view into the open Head Nose Only Unit from above

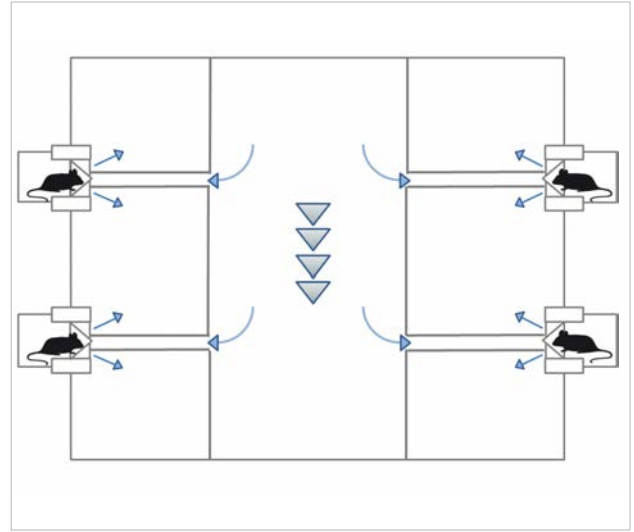

Schematic diagram showing the directed-flow design

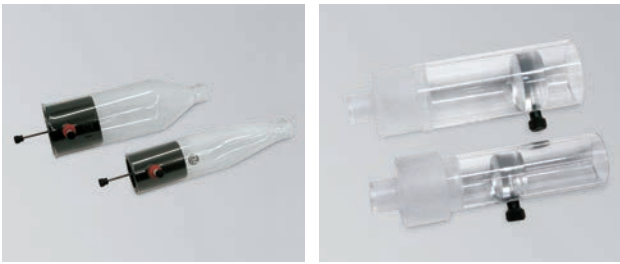

Animal cages made of glass or plastic for rodents

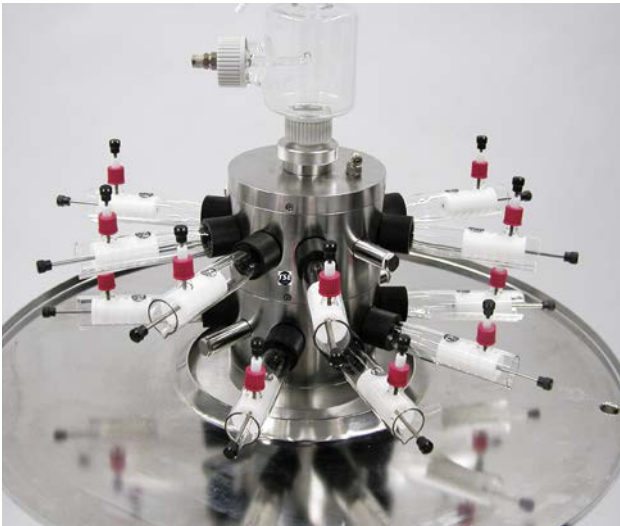

Head Nose Only Unit with small animal cages made of glass

Technical Design

The Head Nose Only Units have a directed-flow design, i.e. there is no rebreathing of expired air. The test atmosphere flows into an inner plenum that directs the flow towards the nose or head of each test animal. The exhaled air is then discarded along with the excess air flow into an outer plenum. The validation of the equilibrium distribution and directed-flow design was carried out in 1994 and 2007 by Prof. Pauluhn.

Features of the Head Nose Only Unit are:

- Cages of different sizes and materials also for special purposes
- Sample ports for taking samples from the central area of the exposure unit in each segment
- Cover with connections for measuring the pressure in the inner plenum as well as the outer plenum and for returning sampled air
- Sampling ports for e.g. a photometer, impactor or sample filter
- Excrement tray for easy collection and disposal of animal feces – easy to clean
- Discharge connections for exhaust air and cleaning purposes
- Device for collecting urine samples for analysis as an option

Head Snout Only Exposure Units



Upper unit with dust generator



Upper unit connections



A Dog Exposure Unit for the application of liquid aerosols with inhalation mask, holding device and leather harness for the dog



Upper unit with sample filter unit

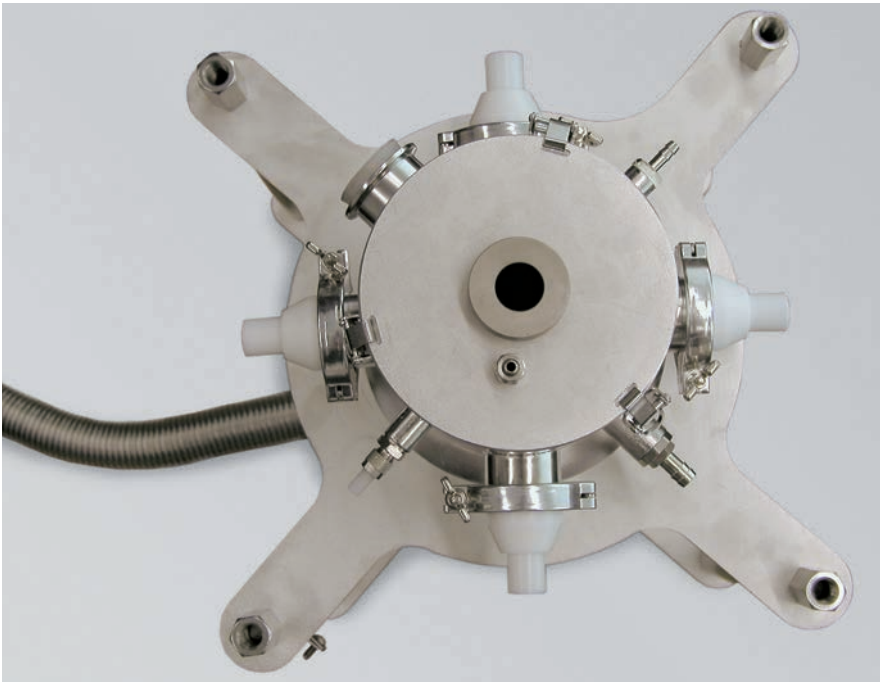

Dog Exposure Unit seen from above



Dog Exposure Unit with ultrasonic nebulizer

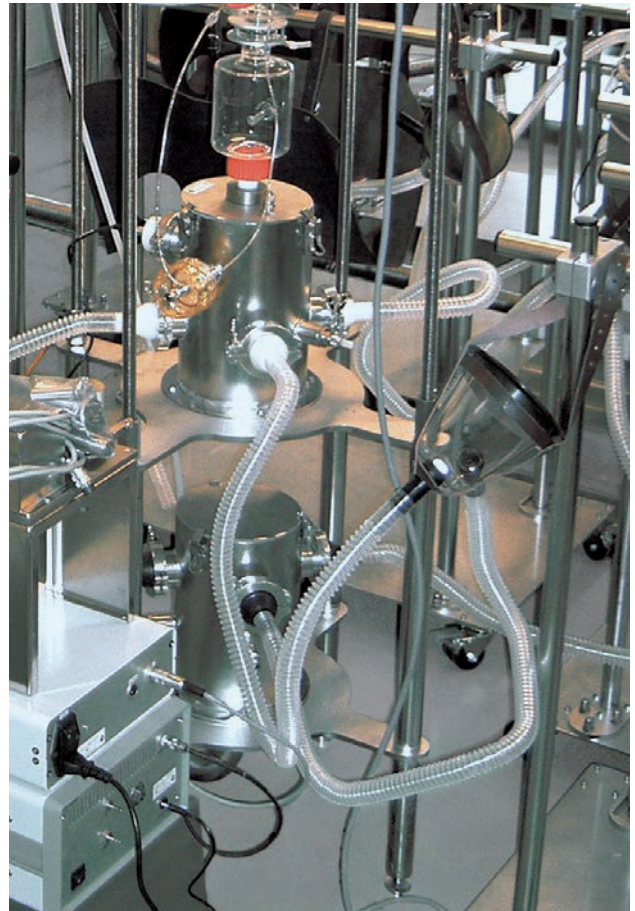

Dog Exposure Unit with dog inhalation mask in front

Exposure Units for Dogs

Special system solutions are Head Nose Only Units for dogs – aerosol administration is possible by using face masks of different sizes. The units can be adapted for the application of liquid and dust aerosols as well as vapors – according to customer-specific requirements.

The standard units are designed for high flow rates of up to 6000 l/h – higher flows are possible if required – and equipped with a mobile animal holding device provided with brakes. On request TSE Systems can also provide exposure units and system components such as seals made of special materials.

Versions for other animals are available on request and adapted according to the user's requirements.

Further system features:

- Spatial separation of fresh and exhaled air – no rebreathing of exhaled air occurs
- Central aerosol administration via various preconditioning units available as standard
- Standard version in stainless steel with plastic ports (e.g. PTFE, Delrine); e.g. for use with face masks
- Sample ports and sensor connections available in both the upper and lower cylinder
- Mobile holding device with comfortable leather harness for the dog
- Different mask sizes for small to large dogs with the proven directed-flow design

Whole Body Exposure Units



Whole Body Unit – standard version

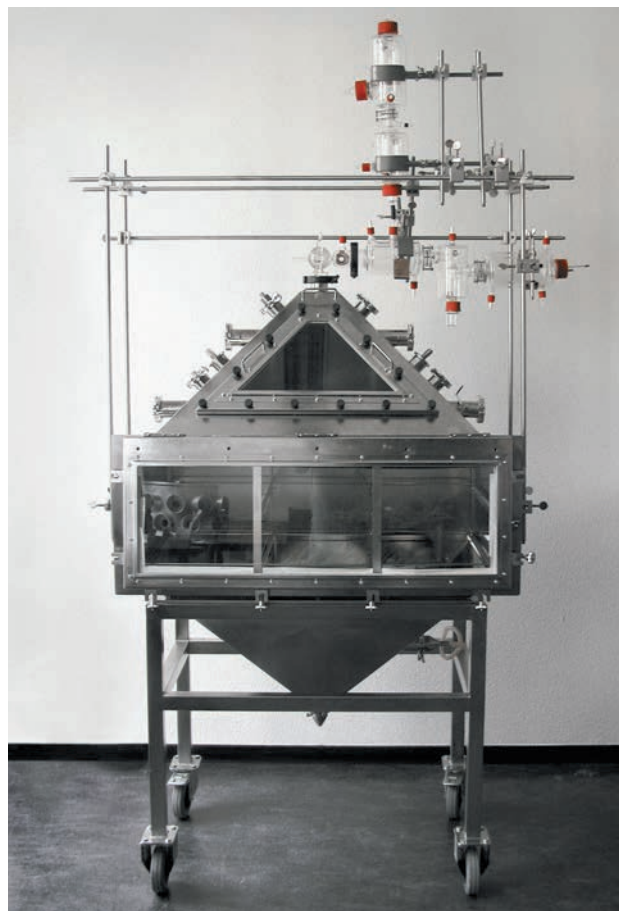

Whole Body Unit for small laboratories

Overview

Whole Body Units allow the simulation of real exposure conditions for a wide range and a large number of animals. Many sizes are available as standard as well as custom-made sizes; the number and type of connections can be specified by the customer at the planning stage.

The homogeneous test substance distribution is guaranteed by the egg-shaped design of the chamber – i.e. square cross section with pyramidal end caps.

Individual features of the Whole Body Units:

- Robust stainless steel design, standard seals available in different materials
- Large viewing port(s) made from safety glass for animal observation included in standard versions

- Various standard sizes of stainless steel cages
- Several types of cage carrier racks are available for the highest degree of flexibility
- Discharge stopcock for detergent solution disposal at the lowest point of chamber

Options

If required, customized specifications such as sample ports, number of windows, etc., as well as special seal materials according to the type of test atmosphere can be implemented.

- Inclusion of a flexible support system for holding the aerosol preconditioning unit(s)
- Holding device for attaching a video camera
- Provision of drinking water for the animals via a built-in tubing system



Whole Body Units with aerosol conditioning and exhaust air line – in the background a mounting panel with flow control units

Spacious Exposure Units

These inhalation chambers are suitable for inhalation studies with animals as large as dogs and primates. Each unit has side-mounted connections for sensors and sampling according to the customer's requirements. The technical execution of the chambers is adapted to suit the large throughput volume of the test atmosphere.

A large number of animal cages can also be accommodated, this is of particular importance for statistical evaluations. Large viewing windows are provided for easy observation of the animals – particularly important during long-term tests.



Whole Body Units for a large number of animals



Side view showing various connections



Inner view of a small Whole Body Unit



Whole Body Unit for one type 3 cage

Units for Laboratory Use

Whole Body Units with a smaller volume are recommended for use with smaller numbers of animals. The egg-shaped design guarantees an optimal flow. The chambers are usually mounted on a mobile rack that can easily be moved about.

- A** Side view of a chamber with connections for sensors, sampling, etc.
- B** Inhalation chamber with viewing door and removable rack for 3 cages
- C** Small mobile chamber version for use with a single cage with flow, filter and sensor units located on the chamber

Environmental Sensors

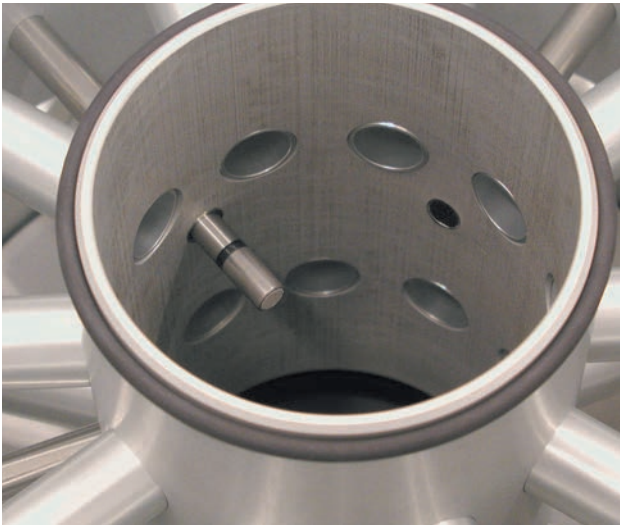

Temperature and humidity sensor in Head Nose Only Unit



Temperature and humidity sensor

Design and specifications of the sensors are adapted for use with the particular inhalation system. The measured values convince because of their high degree of accuracy and reproducibility. Electronic data acquisition of the sensors takes place via state-of-the-art interfaces with automatic transmission and storage of the measurement data. Special sensor holders and ports are provided according to the particular version of the inhalation system.

Sensor types:

- O₂ and CO₂ sensors with high gas specificity and long-term stability
- Space-saving combined sensor for temperature and humidity measurement; can also be integrated in the control procedure for controlling the temperature and humidity of the aerosol
- Pressure sensors for both the exposure unit and also for filter monitoring available; also as chemical-resistant versions
- Special sensors, e.g. for CO, NO, volatile organic compounds (VOCs) such as benzene, O₃, etc., are available on request

Calibration kits are available for sensors which can consist of: pressure calibration unit, flow indicator, thermometer, humidity testing kit, calibration gases according to the system requirements.



Pressure sensor – chemical-resistant model



Pressure sensors – standard version

Aerosol Conditioning Units

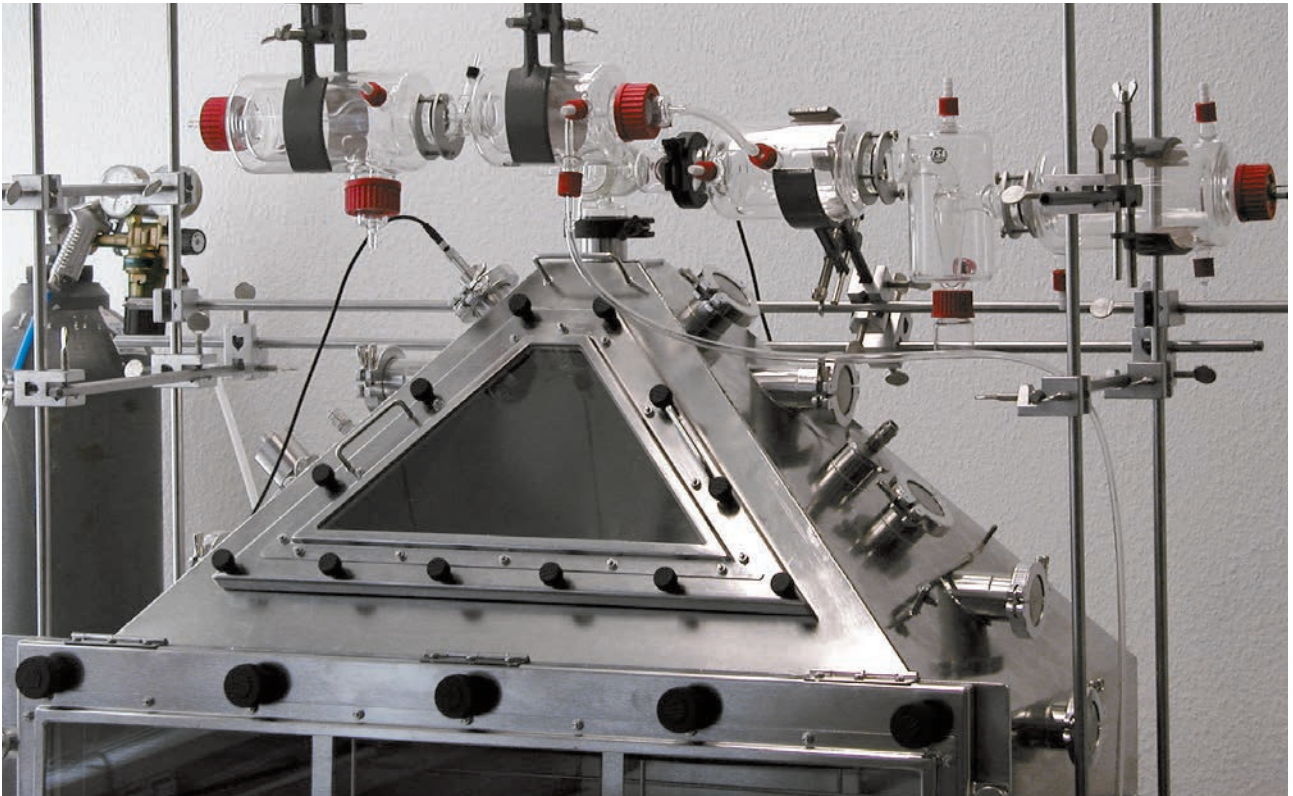

Small Whole Body Unit with aerosol conditioning line

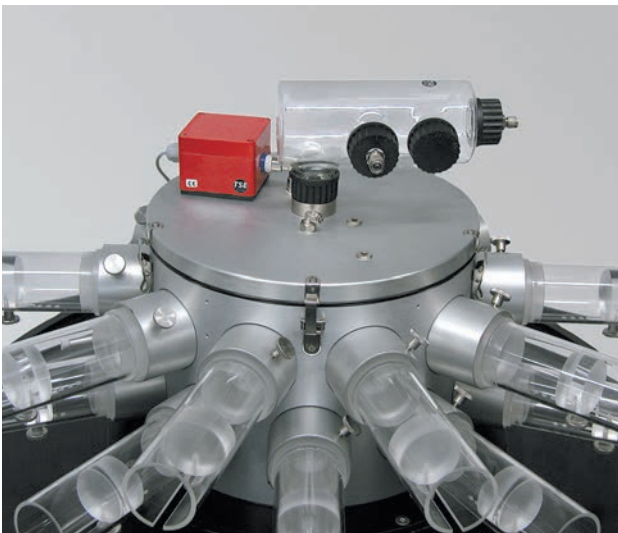

Aerosol-air mixing device with CO sensor



Humidity conditioning line

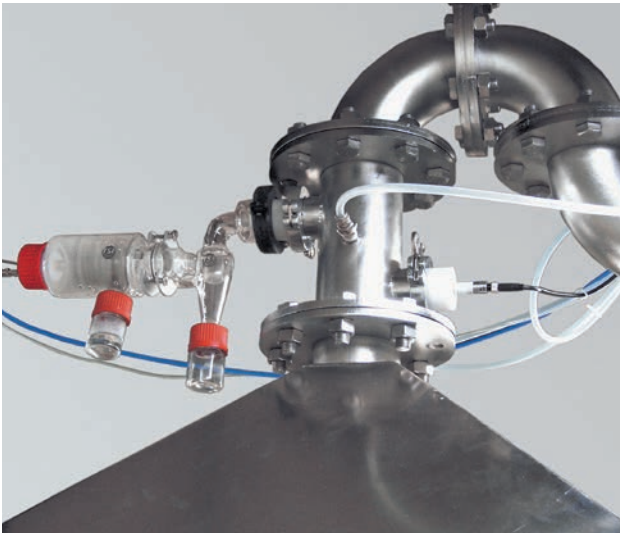

Aerosol conditioning line for Whole Body Unit



Water-jacketed mixing units for aerosol conditioning

TSE Systems provides different kinds of aerosol conditioning units according to the aerosol properties and the individual customer's requirements.

- Dual preseparation of large and small aerosol particles via preseparator and cyclone
- Collection of aerosol remaining in the preseparator unit for reuse or controlled disposal
- Different types of reverse flow mixing devices are available for thorough mixing of aerosol and fresh air – control of aerosol flow and concentration via system adapted sensors, regulation units and Daco software
- Corona Discharge Unit for reducing positive and negative electrical charges on aerosol particles



Corona Discharge Unit

The adjustment of the test atmosphere is possible in the following ways, among others:

- by using controlled humidification units, and
- by thermostating devices in the aerosol supply line such as water-jacketed glassware

The combination of different aerosol conditioning methods is possible as well as a freely adjustable aerosol-to-air ratio via electronic flow controllers. The units can be connected to the different exposure units by suitable adapters or mounting stands.

Liquid Aerosol and Vapor Generators

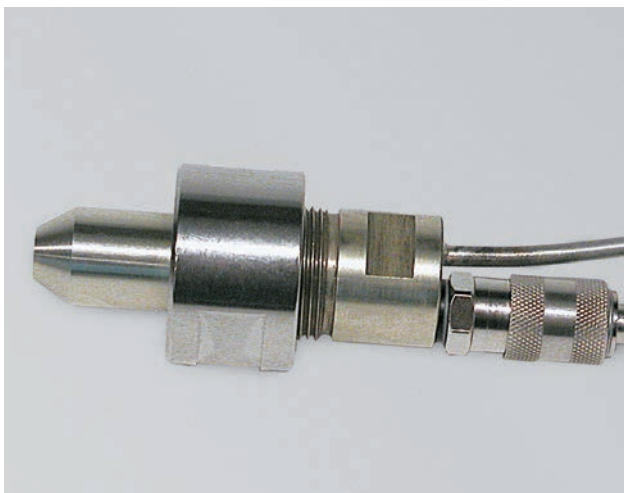

Aerosol nozzle



Aerosol nozzle – outlet area



Aerosol nozzle – mounted on preseparator

Aerosol Nozzles

Various aerosol nozzles are provided for the efficient nebulization of liquids in air and to generate aerosols with different particle sizes, e.g. two-stream nozzles with different specifications. An essential feature of the nozzles is a very uniform cone-shaped cloud of test substance and very small droplet sizes.

Our aerosol nozzles are characterized by

- Small aerosol nozzle size – short dwell time in the nozzle causes rapid spraying of the test substance
- Adjustable nozzle opening so that it is possible to set different spray conditions
- Special design for air-liquid mixing procedure for creation of droplets with a diameter smaller than $3\ \mu\text{m}$
- The possibility of being completely dismantled for easy and thorough cleaning

High-viscosity substances can be dispersed into the test atmosphere by using a heated aerosol nozzle; a nozzle adapter is available for connection to different types of aerosol conditioning units.

The liquid supply to the nozzle is possible via various TSE high-precision dosing units – even for very small amounts/doses of test substance.

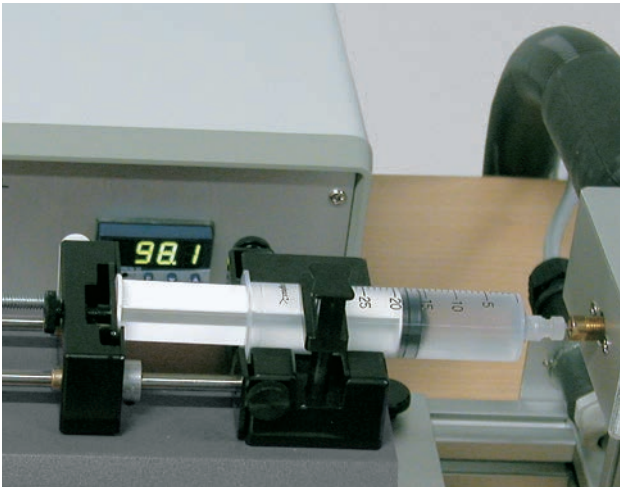

Vapor generator for volatile organic compounds (VOCs)



Ultrasonic nebulizer

As well as the generation of liquid aerosols via an aerosol nozzle, TSE Systems also offers further instruments for aerosolizing liquids, such as ultrasonic nebulizers for the application of small amounts of aerosol and for research into inhaled medications.

The nebulizers are equipped with a disposable substance container – no test substance contamination by residues from previous tests takes place.

Collison nebulizers are recommended for the loss-free nebulization of larger amounts of substance from a liquid reservoir that can be refilled while the test is running (option).

All liquid aerosol generators are equipped with the necessary adapters for connection to the exposure unit.

For working with vapor-air mixtures different types of evaporation units are available depending to the customer's specifications and the particular test substance used.



Collison nebulizer

For example, TSE Systems can provide generators for volatile organic compounds (VOCs) such as benzene, hydrocarbons, etc. for toxicological research, e.g. in investigations into the maximum workplace concentrations of chemicals.

Control and online monitoring of all aerosol or vapor generators is possible with the Daco software (see page 27).

Aerosol Generators for Special Applications

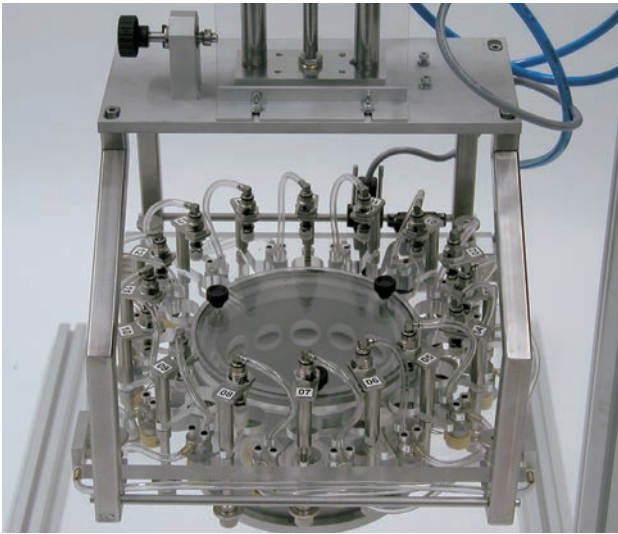

Mixing unit of the MDI Activator-16

MDI Activators and Others

As a special solution in the aerosol generation field TSE Systems offers activators for the automatically controlled triggering of MDIs – single-place and multi-place solutions are available.

Our MDI Activator-16 allows the individual and computer-controlled operation of 16 metered dose inhalers at the same time. The main advantage of an MDI application is the use of test substances consisting of the same compounds or generated under similar conditions to the end-product.

An online control and monitoring software is used together with the MDI Activator. All parameters such as shaking time, activation time, pause time, filling activators and activation pattern are entered within the application planning window in a clear, separate window.

TSE Systems can offer further user-specified generators for the generation of test atmospheres such as ozone generators and special spray cans on request.



MDI Activator-16

Nanoparticle Research Instruments

In cooperation with experts from leading research institutes and universities TSE Systems develops nanoparticle generators as well as the analytical instruments for research into inhalable nanoparticles. According to the study design the instruments are adapted to the system configuration – individual instrument specifications on request. For further information please refer to page 30.

Dust Generators



Dust Generator acc. to Wright

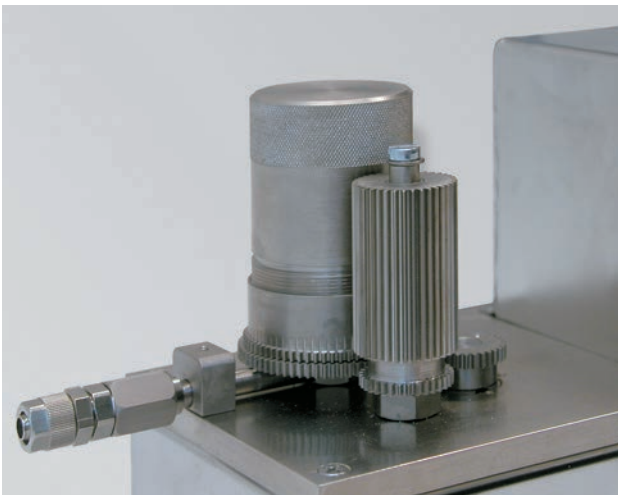

Dust generating mechanics

Dust Generators acc. to Wright

Dust Generators acc. to Wright are designed for working with finely powdered and dry substances. They are made from robust, wear-resistant material like stainless steel and operate with an exact and accurate mechanism.

They are available with

- Small and large dust reservoirs – for low and high substance concentrations
- Automatic and manual operation control

In the automatic operation control version aerosol generation takes place with simultaneous concentration measurement using a concentration measuring unit (option). A pneumatic press for compressing the substance in the reservoir is also available.



Bundschuh Dust Generator

Bundschuh Dust Generator

The Bundschuh Dust Generator is for use with loose materials and for generating high aerosol concentrations as well as for long-term tests. It has been designed to disperse amounts from 10 g to 550 g per hour and can also be used with finely ground fibrous substances and without previous test substance compression.

The substance reservoir is equipped with stirrer and ventilation for continuous dust conditioning during the experiment and the test substance is dispersed by a venturi nozzle which is driven by compressed air.

The perfect setting of aerosol concentration is guaranteed by a coarse and fine adjustment mechanism.

Cigarette Smoke Generators

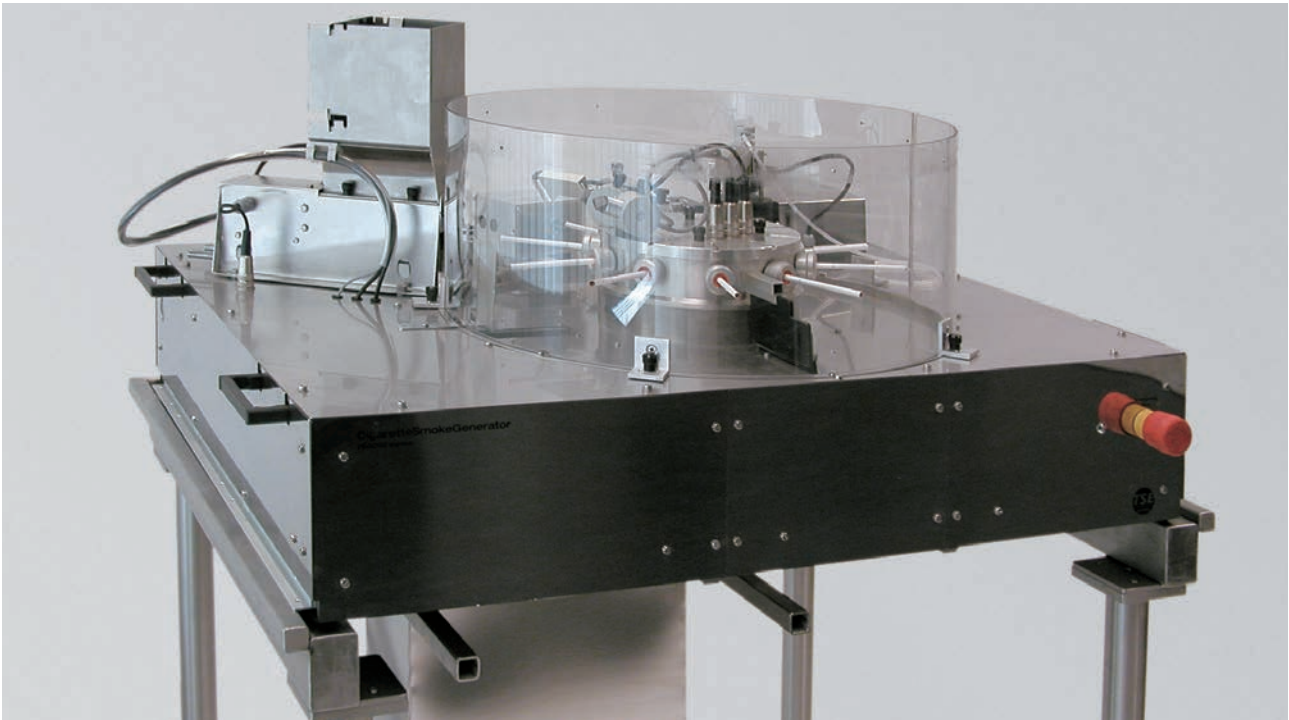

Cigarette Smoke Generator with cigarette wheel and cigarette magazine



2-port Cigarette Smoke Generator

The 2-port Cigarette Smoke Generator is suited for studies with small exposure volumes.

Our Cigarette Smoke Generator is designed for automatically producing cigarette smoke for analytical and experimental investigations such as COPD studies into health damage caused by cigarette smoke. The instrument offers automatic filling, igniting, smoking, ejecting and reloading of cigarettes. It is equipped with different sensors for monitoring current machine status such as butt length, cigarette loading, burning cigarettes, etc.

- A wheel for 10 cigarettes as standard, other versions available on request
- Continuous cigarette smoking for several hours is possible – smoked cigarettes are automatically ejected and new cigarettes are reloaded
- Cigarette magazine for up to 250 cigarettes for continuous reloading during operation; the capacity can be further increased as an option
- For use with standard cigarettes of different sizes and diameters

The smoking of cigarettes according to ISO profile – 1 puff/min, 35 ml/puff, 2 seconds duration – is possible. The advanced model offers additionally the possibility for various settings of drawing and puff duration, puff volume and max. number of puffs.



Automatic loading of a cigarette

Control and recording software

The test parameters for the Cigarette Smoke Generator can be set by using the SMG-10 software. During the experiment the operating status and individual actions can be followed by the status display in the software.

The status display shows a graphical presentation of the wheel, a table with test data and several submenus to define experiment parameters. The entry of control parameters such as puffs per minute, puff volume, max. number of puffs per cigarette as well as descriptive text can be made via the setup menu.

Different puff profiles can be set for smoking a cigarette – bell, ramp, rectangle.

An additional menu for monitoring and testing the hardware inputs/outputs is available as well as a software function for checking the mechanical operation, e.g. rotation of the cigarette wheel if no experiment is taking place.

The whole smoking process, e.g. number of smoked cigarettes, smoke volume generated, etc., is recorded automatically, shown and saved in table format.

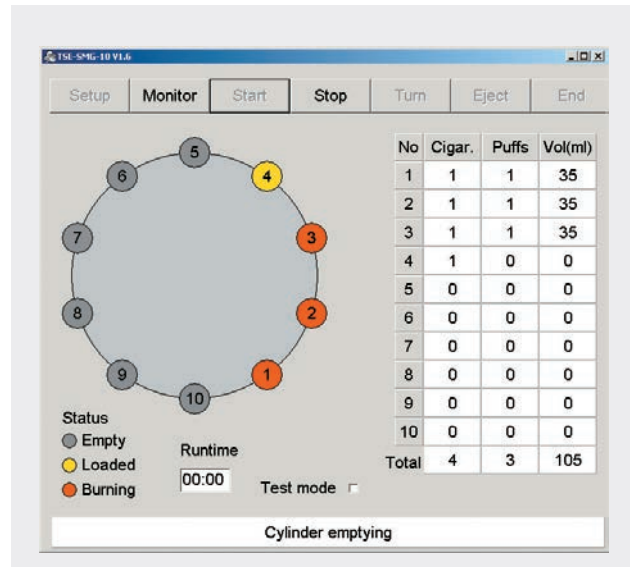

Status display of a cigarette wheel and measuring data

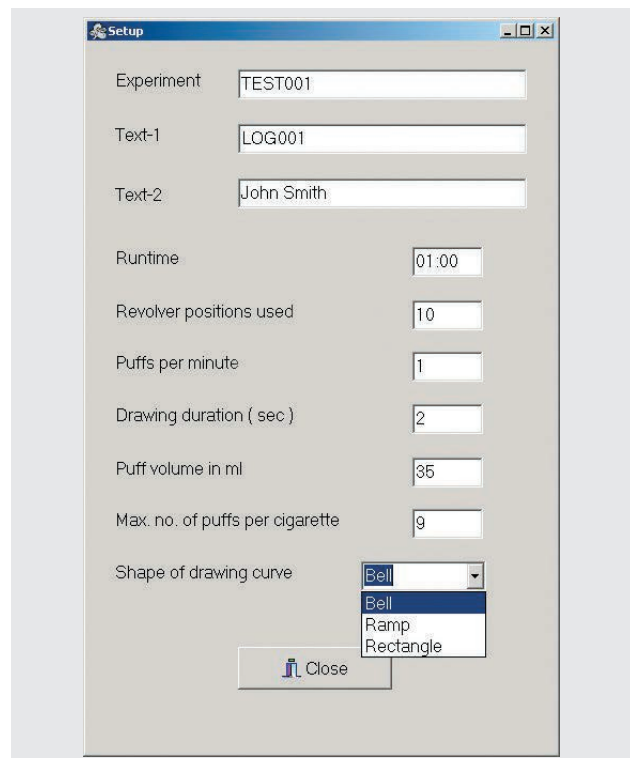

Setup menu Cigarette Smoke Generator

Offline Aerosol Analysis

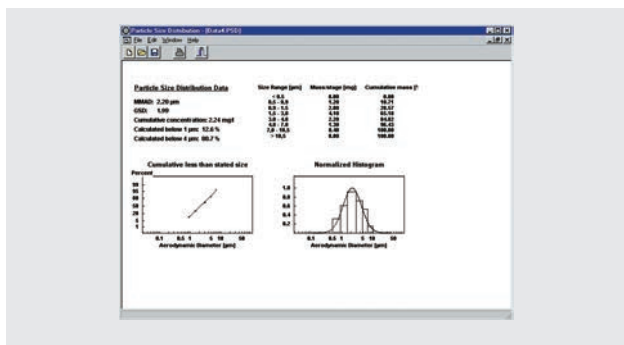
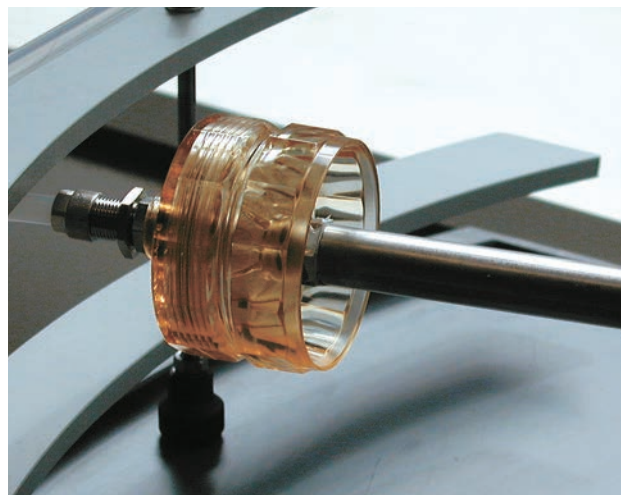

Cascade impactors: 0.5 l/min and 6 l/min and evaluation software

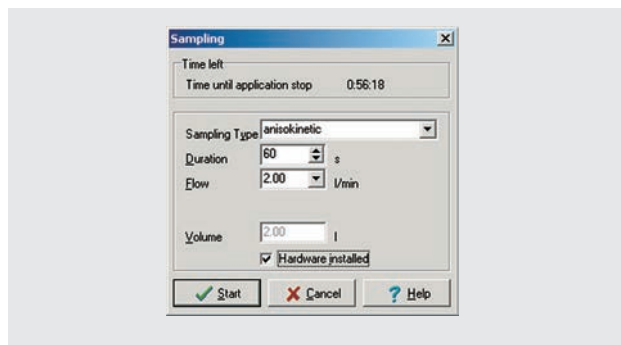

Filter analysis unit at Head Nose Only Unit and sampling menu

Cascade Impactors

Various cascade impactor designs are available for determining the particle size distribution and the mean mass aerodynamic diameter MMAD as well as the aerosol concentration. Different versions are available as standard – e. g. Mercer style with seven stages.

Technical design:

- High-precision finishing of the impactors, particularly the individual impactor stages
- Supplied with a special tool for dismantling the individual impactor stages as standard
- Stainless steel collection plates for sampling of impacted particles

TSE Systems also provides a Particle Size Distribution software for the computer-supported evaluation of impactor analyses.

Filter Analysis

Filter analysis is a favorably priced solution for “basic equipment”. Simple gravimetric determination of particle concentration is carried out by weighing out the amount of substance collected. According to the particular test substance used, different filter materials such as glass fiber, quartz fiber, PTFE, or cellulose nitrate in reusable filter capsules can be used. Concentration analysis is also possible by subsequent analytical methods such as HPLC, fluorescence spectroscopy, etc.

Additional sampling features:

- Sampling pumps and mass flow controllers for generating and regulating the sample flow in different versions
- Protection of sampling components against residual test substances by using suitable protective filters
- Computer-supported sampling with simultaneous storage of sample flow, sampling time, etc.

Real-Time Aerosol Analysis



OptoPan, a virtual impactor and sketch of the working principle

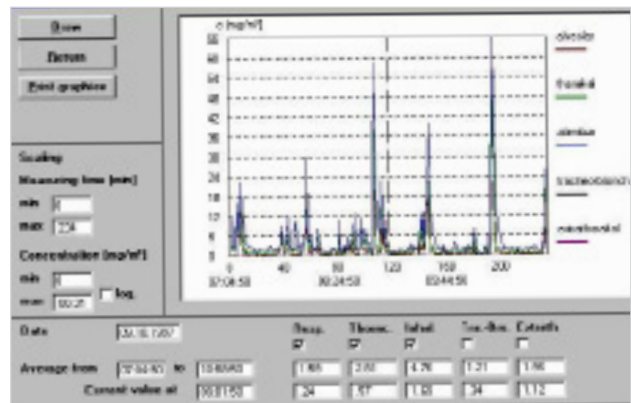

OptoPan Software: data measuring display



OptoPan Equipment case

OptoPan

OptoPan collects and monitors three size ranges important for the analysis of liquid and dust aerosol deposition in the lung of the animals with only one sampling head.

It is a virtual impactor and its measuring principle is based on the combination of inertial classification and concentration enrichment using a virtual impactor, filter sampling and aerosol photometry.

The measurement is made by using the combination of 3 photometric sensors for real-time monitoring and a 2-stage virtual impactor for offline analysis.

Filter disks are available from different materials. A data logger can be provided for measurement setup and data storage.

Measurements of average concentrations and monitoring of variations in mass concentration with time are possible.



SpectroPan control unit with function display

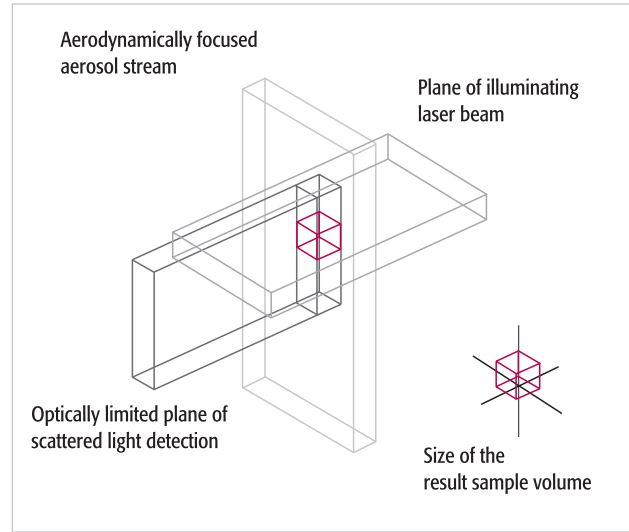

Working principle of the optical unit

SpectroPan

SpectroPan is a real-time analysis system for various applications such as inhalation studies, general measurement of particle size (e. g. for aerosol research), air quality analysis, reference measurements performed with calibration aerosols, validation of aerosol generators (e.g. spray cans, MDIs, dust generators and nozzles), filter testing and characterization.

TSE Systems provides a comprehensive software package for determination of particle size distribution (number, surface, volume, mass) and concentration, including statistics functions. The measurement data can be displayed as a graph or table.

Instrument design

- Recording particle size distribution, particle diameter and aerosol concentration
- Up to 64 particle size classes can be differentiated
- High sensitivity due to HeNe laser technology
- Minimized measuring volume for light scattering on single particles
- Sheath airflow effectively protects the optical components of the system from direct aerosol contact

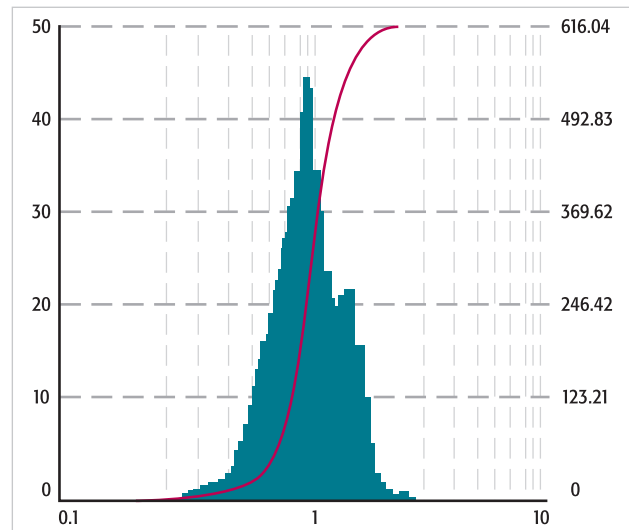

Distribution curve of an analysis

Particle Sizes 0.3 to 20 μm and particle concentration $< 10^5$ particles/ cm^3 can be measured. The calibration can be carried out with PSL aerosols (particle size standards) and DEHS droplet aerosols (diethyl-hexyl sebacate).

Inhalation Software

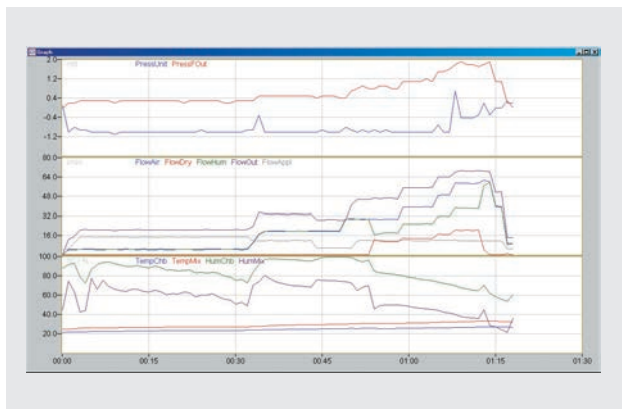

Graphical presentation of measurement parameters

Setup menu with functions for the experiment design

Daco

Overview

The Daco Software is designed for controlling and recording inhalation studies with exposure units. It is available as a version for controlling several similar exposure units – from a single computer.

The software is designed to suit the system configuration and can be adapted accordingly to accommodate system extensions.

- Easy and quick planning of experiments and setting of experiment parameters such as test description, flow and pressure parameters, acquisition time, alarm functions, etc.
- Clearly arranged representation of data in tables or graphic displays
- Display of system status and measurement data while test is taking place
- Setting of alarm limits for system parameters such as pressure, flow, temperature etc.
- Safety features such as automatic shutdown and emergency stop as well as manually triggered shutdown function for rapid and safe system shut-down
- Separate setting of regulation functions for pressure, temperature and humidity
- Input monitor for viewing the current measured raw data for test purposes
- Menu for setting the number of decimal places to be displayed – independent of the measured value resolution

Raw data recording and experiment protocols are according to GLP requirements. For safety reasons different authorization levels are provided; these can be blocked via a password-protected menu.

Further exemplary software features of Daco, in compliance with GLP requirements:

- Audit trail for the automatic recording of GLP-relevant test data – access can be password-protected if necessary
- Saving of calibration data in a special file. Additional saving of calibration data together with the associated sensor raw data for a measurement
- Protection against subsequent manipulation of raw data through special data file format
- All entries are logged by the system with the corresponding time and date
- Automatic recording and display of alarm events and test information entered by the user

Customer-specific GLP requirements can be implemented on request.

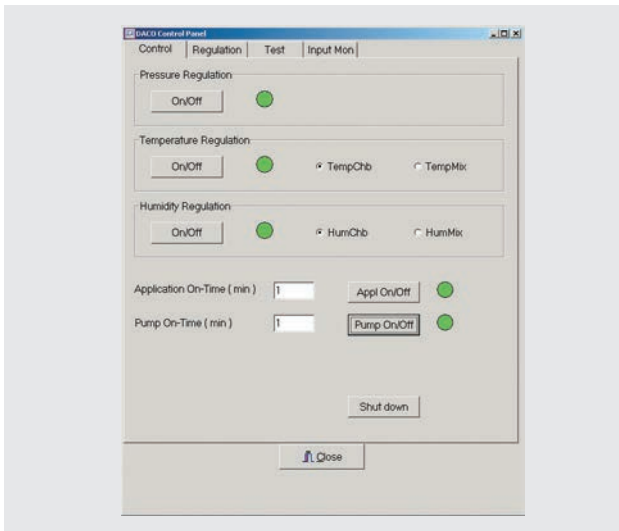

Setting regulation functions

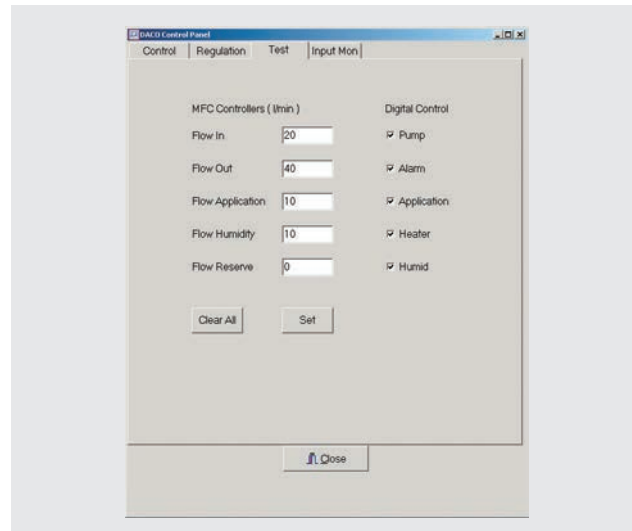

Activation of test functions for system components

Software features

Daco software provides the automatic recording of test descriptions, measurement data and system status such as the current pressure, flow, etc. Different control menus are available to check the status and functioning of the inhalation system.

- The control menu permits the manual switch-on and switch-off of the control for pressure, humidity, etc.
- With the test menu the user can check single system components: mass flow controllers, application pumps, alarm units, etc.
- The regulation menu is a service tool with which hardware-specific parameters can be optimized
- The input monitor displays the current measured ADC values and provides a measure for the plausibility of the measured values and the utilization of the different sensors.

An export function is provided for further data processing in additional evaluation software, e.g. statistical analyses or presentation programs such as Excel, etc.

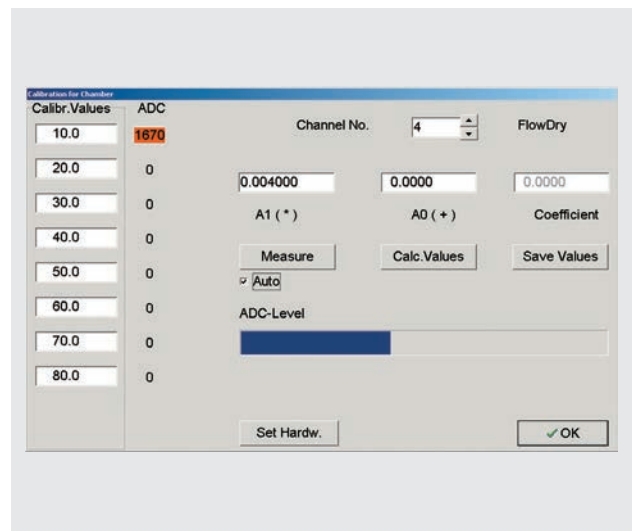

Calibration menu – in this case for the temperature sensor

For calibration purposes a calibration menu is provided.

- One calibration channel for each individual sensor such as pressure, temperature, humidity etc.
- Up to 8 calibration values are possible for each sensor
- Automatic measured value scanning with simultaneous graphical presentation
- Calculation of the calibration factor by linear regression and storage of the calibration data

Cell Culture Exposure System



Cell Culture Exposure System



Exposure units for cell cultures

Crucial tool for in-vitro studies

Cell Culture Systems are finding increasing use in inhalation studies. The TSE Cell Culture Exposure System offers an efficient, user-friendly tool for supplementing and amplifying inhalation research programs.

- Time-saving and favorably priced procedure for screening tests with tissue materials
- For connection of our aerosol or vapor generators – special solutions on request
- Adapted cigarette smoke generator for cell cultures – enabling a reduced smoke concentration, crucial for cell culture exposure
- Simultaneous exposure of cell cultures in two separate exposure units via one aerosol generator
- Different substance concentrations in the exposure units in combination with the multi-stage dilution system

Units for quick screening

- Cell culture exposure units for a uniform aerosol, cigarette smoke or vapor dispersion
- Each exposure unit is suitable for 12 up to 48 Transwell® wells
- Exposure of the wells, via an internal flow plate for equal and consistent dispersion
- Humidification and integrated heating, for longer viability of exposed cell cultures



Exposure unit equipped with wells

Nanotechnology

E-Spray NanoGen

TSE Systems has developed the E-Spray NanoGen nanoparticle generator in close collaboration with leading research institutions. Using free electrospray technique, the E-Spray NanoGen can be used for *in-vivo* and *in-vitro* experiment setups. With this nanoparticle dispersion system a wide variety of materials can be used to generate a uniform nanoparticulate exposure atmosphere.

Advanced technical and safety features make the E-Spray NanoGen ideal for applications such as:

- Exposure studies of nanoparticles
- Nanoparticle disposition research
- Nano-Aerosol analysis

The E-Spray NanoGen is a substantial modular expansion to complete inhalation exposure systems to perform nanoparticulate matter studies.

Nanoparticle Analysis

TSE Systems offers equipment for the measurement of nanoparticle concentration as well as nanoparticle size distribution.

The Condensation Particle Counter (CPC) is a portable all-in-one counter for ultra fine particles down to $d_{50} = 4.5$ nm. The unit contains all required components, like pumps, butanol tank and supply and has an integrated intelligence to control a proper operation.

In the Differential Mobility Analyser (DMA) the particles are selected according to their electrical mobility. The mobility in an electrical field depends on the mechanical mobility of a particle and its electrical charging. The voltage and the geometrical properties of the analyser determine the size range of particles, which can be detected by a DMA.

The integration of both measurement methods creates a high resolution Nanoparticle Analyzer for particle sizes from to 5-1100 nm which is suitable for nearly every kind of research study as well as process monitoring.



E-Spray NanoGen – *in-vitro* setup



Differential Mobility Analysers

- CPC for ultra-fine particles down to 4.5 nm
- Detection of particles over a very wide concentration range from single events up to 10^7
- DMA for classifying the particles according to their size
- Special design with high resolution and low particle loss

Product Overview

This overview illustrates additional products which are supplied by TSE Systems, detailed information concerning each of the items listed below can be found on our website, for any additional information please do not hesitate to contact us:

■ **Behavior**

Learning & Memory (Operant Behavior), Conditioning, Activity & Exploration, Video Tracking, Mazes, Startle Response, Anxiety & Depression, Motor Function & Performance, Rotameter

■ **PhenoMaster / LabMaster**

Calorimetry, Drinking & Feeding & Body Weight, Home Cage Activity, Running Wheel
Operant Wall, Mice & Rats

■ **NewBehavior Products**

IntelliCage (cognitive screening for up to 16 mice living in a social group in a home cage environment),
NeuroLogger (4 channels wireless EEG recording & activity)

■ **Kinematic Analysis**

MotoRater (evaluation of locomotor functions using high-speed video tracking: Ladder / Walking / Wading / Swimming)

■ **Analgesia**

Hot Plate, Tail Flick, Randall Selitto, Power Meter (Incapacitance Tester)

■ **Physiology**

Blood Pressure Monitoring – invasive & non-invasive, Telemetry, Volume Meter

■ **Inhalation**

Head Nose Only, Whole Body and Cell Culture Exposure Units, Aerosol Generation & Conditioning,
Cigarette Smoke Generators, Aerosol Analysis, Inhalation Software

■ **Stereotaxic Instruments**

■ **Isolated Organs**

■ **Microtomes**

Krumdieck Tissue Slicer

■ **Pumps & Infusion**

Syringe Pumps, Animal Infusion Systems

■ **Surgery & Handling**

Operating Tables, Homeothermic Blankets, Temperature and ECG Pads

TSE Systems offers additional modules to create a complete exposure system. Please find out more about:

■ **Head Nose Only Exposure Units**

Modular, stackable structure for different size conditioning units. Available for animal sizes from mouse to dog with directed-flow principle

■ **Whole Body Exposure Units**

Robust, user-friendly design for homogeneous test substance distribution. Different volumes available for variable animal sizes and test animal numbers

■ **Cell Culture Exposure System**

Ideally suited system for screening tests with tissue, using Transwell® inserts of varying sizes. Extended viability of cultures by heating/humidification

■ **Nanoparticle Analysis**

TSE System offers instrumentation to analyze nanoparticle size and concentration, such as Condensation Particle Counter or Differential Mobility Analyzer

■ **Daco Inhalation Software**

Control and recording software for inhalation systems with multi-control mode for system extension. Advanced safety and GLP compliance features

■ **Sensors and Controllers**

TSE Systems supplies a number of environmental sensors and mass flow controllers specifically designed for each inhalation system

– *Specifications subject to change without notice* –

Service & Warranty

TSE Systems offers a Two (2) Years ALL-IN Premium Warranty with all new products, including:

- 24/7 technical hotline
- Remote maintenance and update function
- On-site visits upon necessity
- Free replacement parts

After the expiry of the warranty period, TSE Systems offers comprehensive extensions of the warranty or economical maintenance and repair contracts to ensure the continued smooth running of your instruments. Please contact us for further details.

